

RACKS

SERVER CABINET

A SERVER CABINET IS A COMBINATION OF HARDWARE STRUCTURES DESIGNED TO ACCOMMODATE TECHNICAL EQUIPMENT INCLUDING (ROUTERS, SWITCHES, HUBS, UPSs, CABLES) AND, OF COURSE, SERVERS.



NETWORK CABINET RACK 47U 60*100

NS-503GL47U60100

FEATURES

- Best sales and famous model floor rack.
- Reliable structure,static loading capacity: 800KGs (Optional castors and plinth).
- Adjustable feet and heavy duty castors are available simultaneously,moving conveniently and fixing reliably.
- Baying together easily,quickly,efficiently and firmly.
- Glass front door with metal panel and rear metal door
- Optional cable entry on top cover and bottom panel. Front,rear door and side panel can be removed facility, the bottom has the function of ventilation and rat-proof.
- Varies optional accessories,reliable quality.
- Optional opening hole and varies specification upon customers' special requirements.
- 8 heights: 18U,22U,24U,27U,32U,37U, 42U,47U (Can customize).

- 3 depth option: 800, 900 and 1000mm.
- Flexible packing methods allows for convenient stocking and end user delivery.
- Multiple sizes available.
- Customization requests welcome.

STANDARD AND MATERIAL

Comply with

- ANSI/EIA;RS-310-D;IEC297-2; DIN41491:PART1; DIN41494:PART7; GB/T3047.2-92
- Standard and ETSI standard.(grey).

SURFACE TREATMENT

- degreasing,pickling,phosphoric, powder coating.

MATERIAL

- SPCC cold rolled steel.

THICKNESS

- Mounting profile 2.0mm;
the others:1.0-1.2mm.

COLOR

- Body color:RAL9004(black);
RAL7035(grey).

DIFFERENT ANGELS

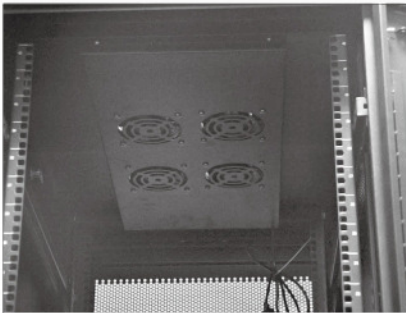

• Top cover



• Mounting angle

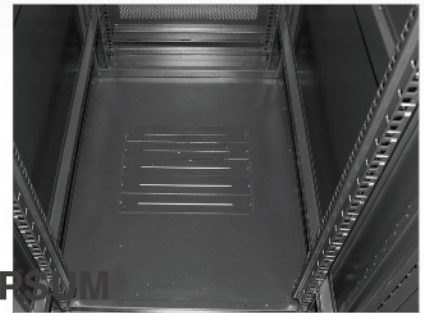

• Bottom panel

L

DOOR CATEGORY COLLECTION

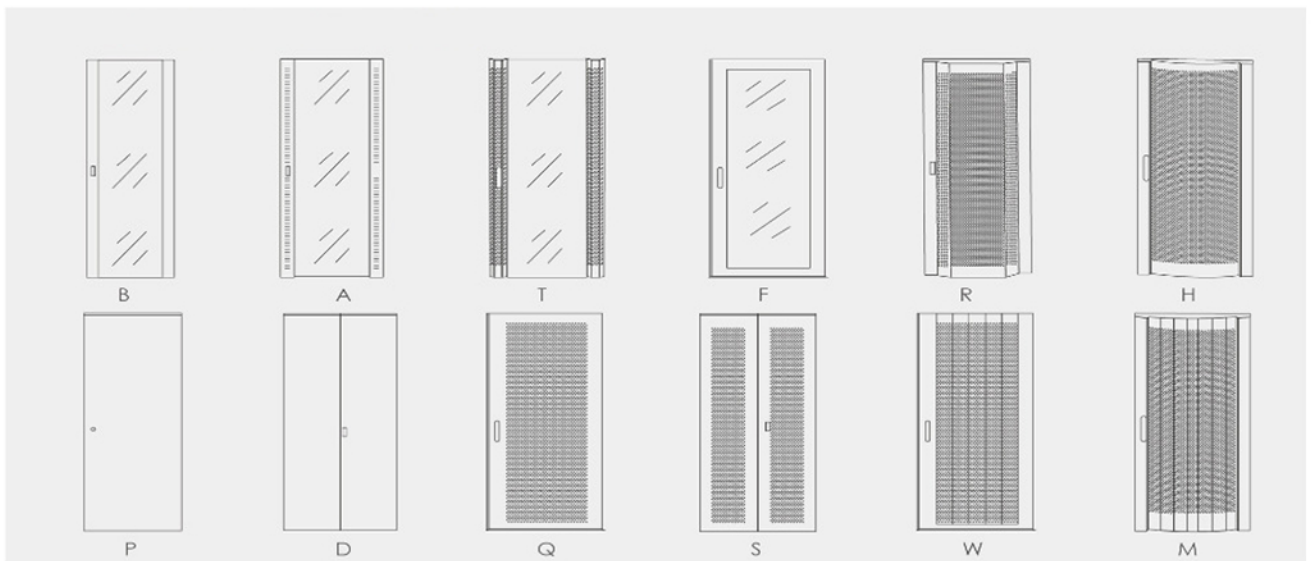

RACK LAYOUT

No.	Name	Qty	SPCCT (mm)	No.	Name	Qty	SPCCT (mm)
1	Frame	2 PCS	1.2	14	High density vented door	1 PCS (Quantity as request)	1.2
2	Mounting angle	4/6 PCS	1.2	15	Front door hexagonal reticular vented door	1 PCS (Quantity as request)	1.2
3	Mounting Profile	4 PCS	2.0	16	Vented rear door	1 PCS (Quantity as request)	1.2
4	Top cover	1 PCS	1.2	17	Steel front door	1 PCS	1.2
5	Bottom panel	1 PCS	1.2	18	Double-section vented door	1 PCS (Quantity as request)	1.2
6	Fan tray	1 PCS	1.0	19	Front door hexagonal reticular vented plate door	1 PCS (Quantity as request)	1.2
7	Panel	3 PCS	1.0				
8	Cable entrance panel	5 PCS	1.0				
9	Fixed shelf	Quantity as request	1.2				
10	Castor	4 PCS	/				
11	Side panel	2 PCS	1.0				
12	Tempered glass door	1 PCS	1.2				
13	Front door toughened glass & plate door border	1 PCS (Quantity as request)	1.2				

Remark: The cabinet size above 37U using 6 pcs mounting angle, under 37U using 4 pcs

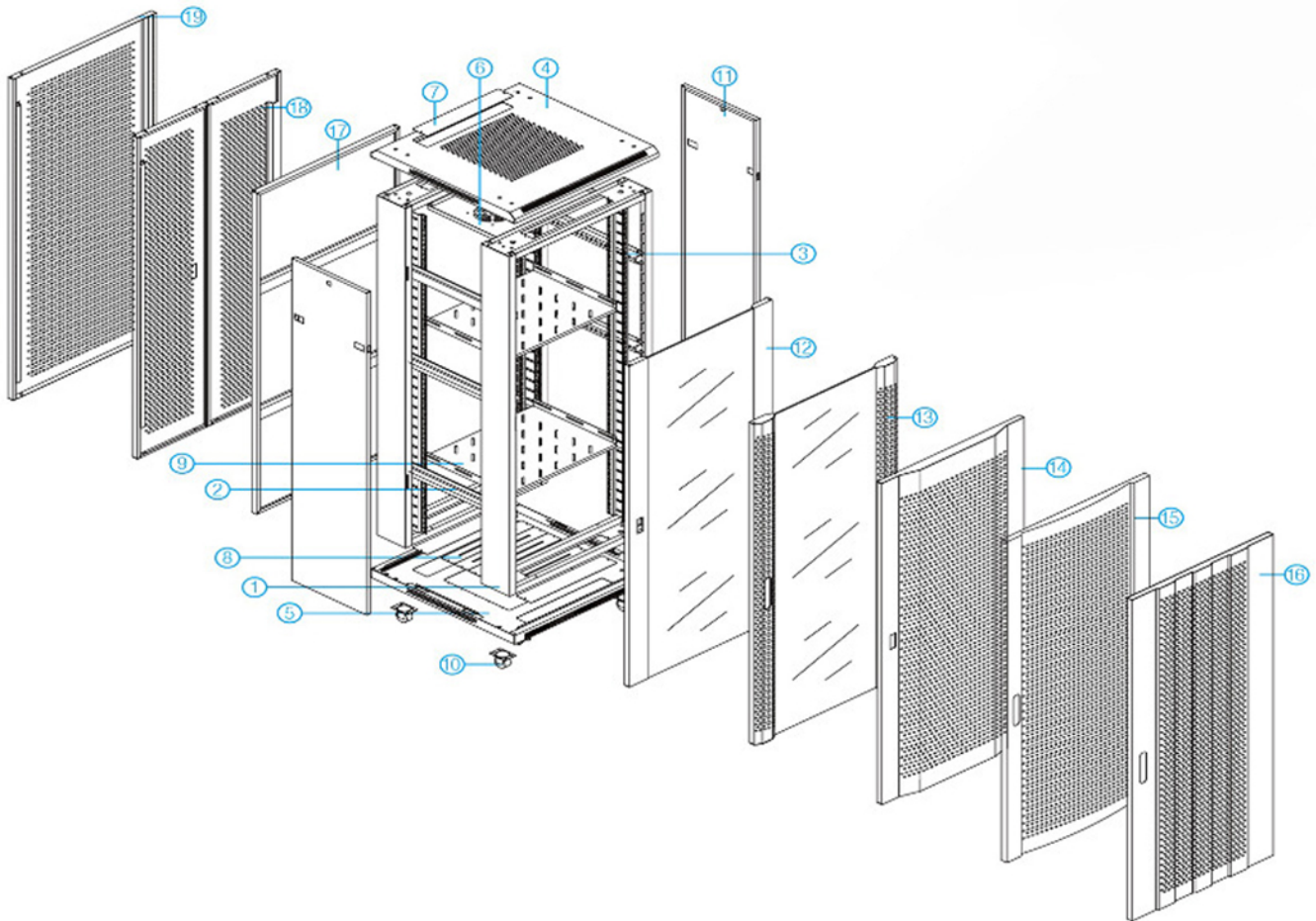

TECHNICAL SPECIFICATION

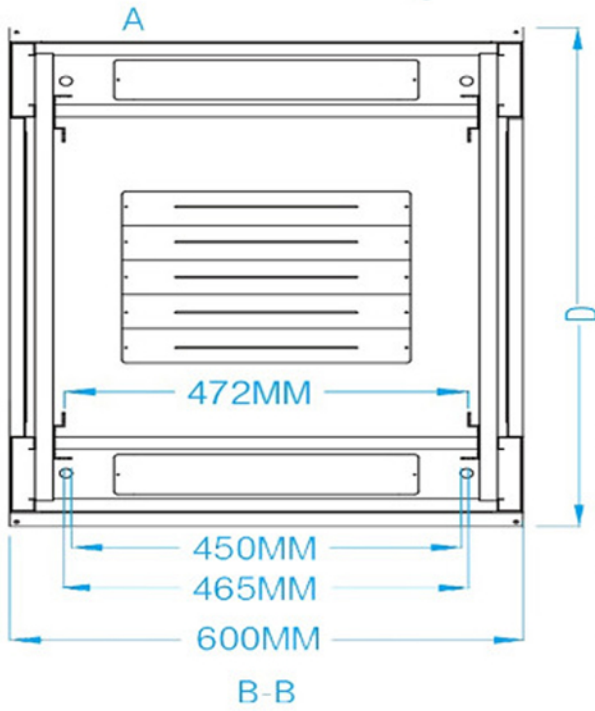

Model	U	Width	Depth	Height
NS-503GL18U6080	18	600	800	900
NS-503VN18U6080			800	
NS-503GL18U60100			1000	
NS-503VN18U60100			1000	
NS-503GL22U6080	22	600	800	1080
NS-503VN22U6080			800	
NS-503GL22U60100			1000	
NS-503VN22U60100			1000	
NS-503GL24U6080	24	600	800	1150
NS-503VN24U6080			800	
NS-503GL24U60100			1000	
NS-503VN24U60100			1000	
NS-503GL27U6080	27	600	800	1300
NS-503VN27U6080			800	
NS-503GL27U60100			1000	
NS-503VN27U60100			1000	
NS-503GL32U6080	32	600	800	1525
NS-503VN32U6080			800	
NS-503GL32U60100			1000	
NS-503VN32U60100			1000	
NS-503GL37U6080	37	600	800	1745
NS-503VN37U6080			800	
NS-503GL37U60100			1000	
NS-503VN37U60100			1000	
NS-503GL42U6080	42	600	800	1965
NS-503VN42U6080			800	
NS-503GL42U60100			1000	
NS-503VN42U60100			1000	
NS-503GL47U6080	47	600	800	2190
NS-503VN47U6080			800	
NS-503GL47U60100			1000	
NS-503VN47U60100			1000	

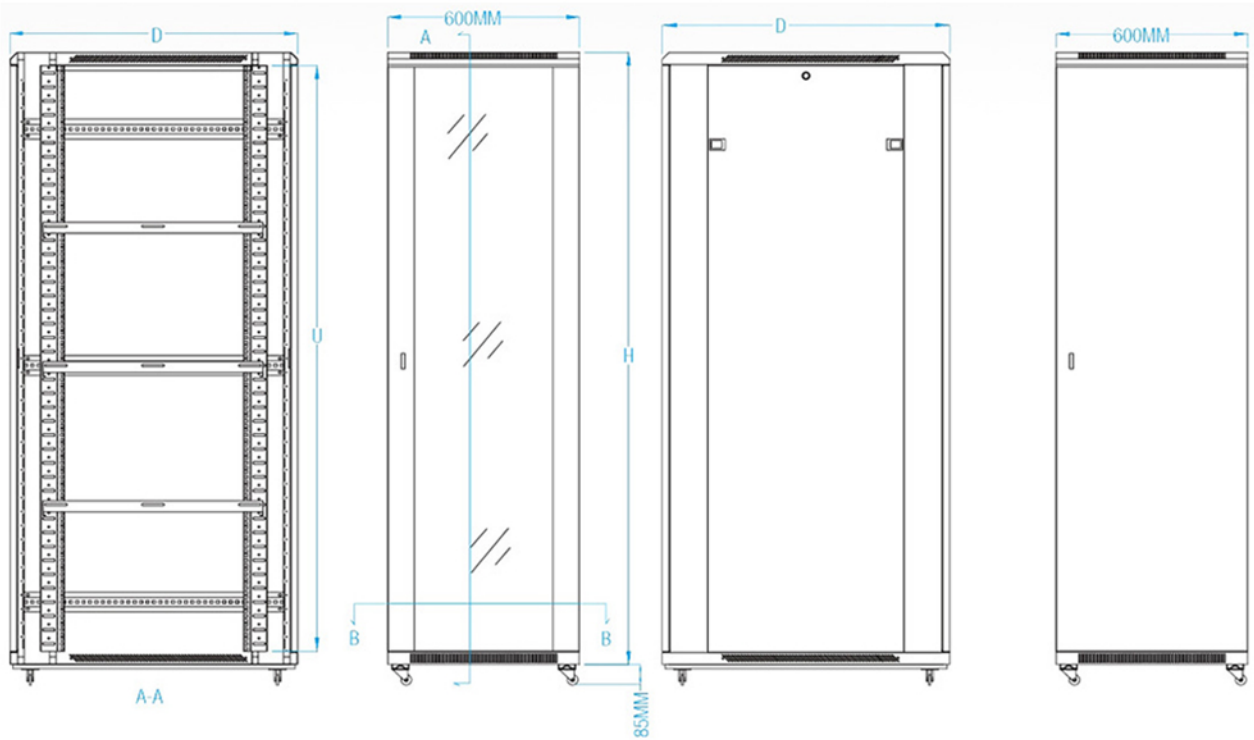

RACK INSTALLATION

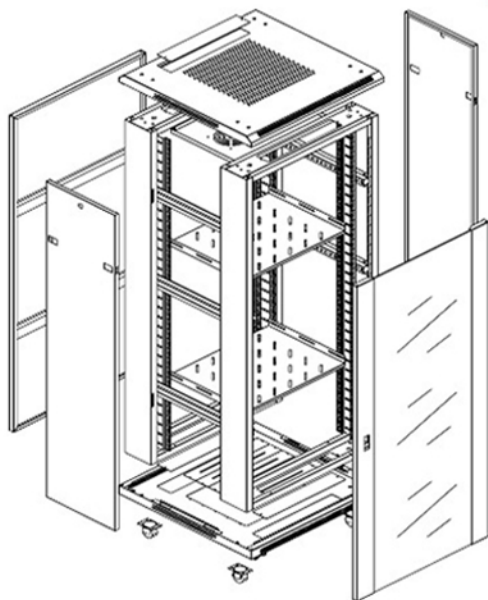
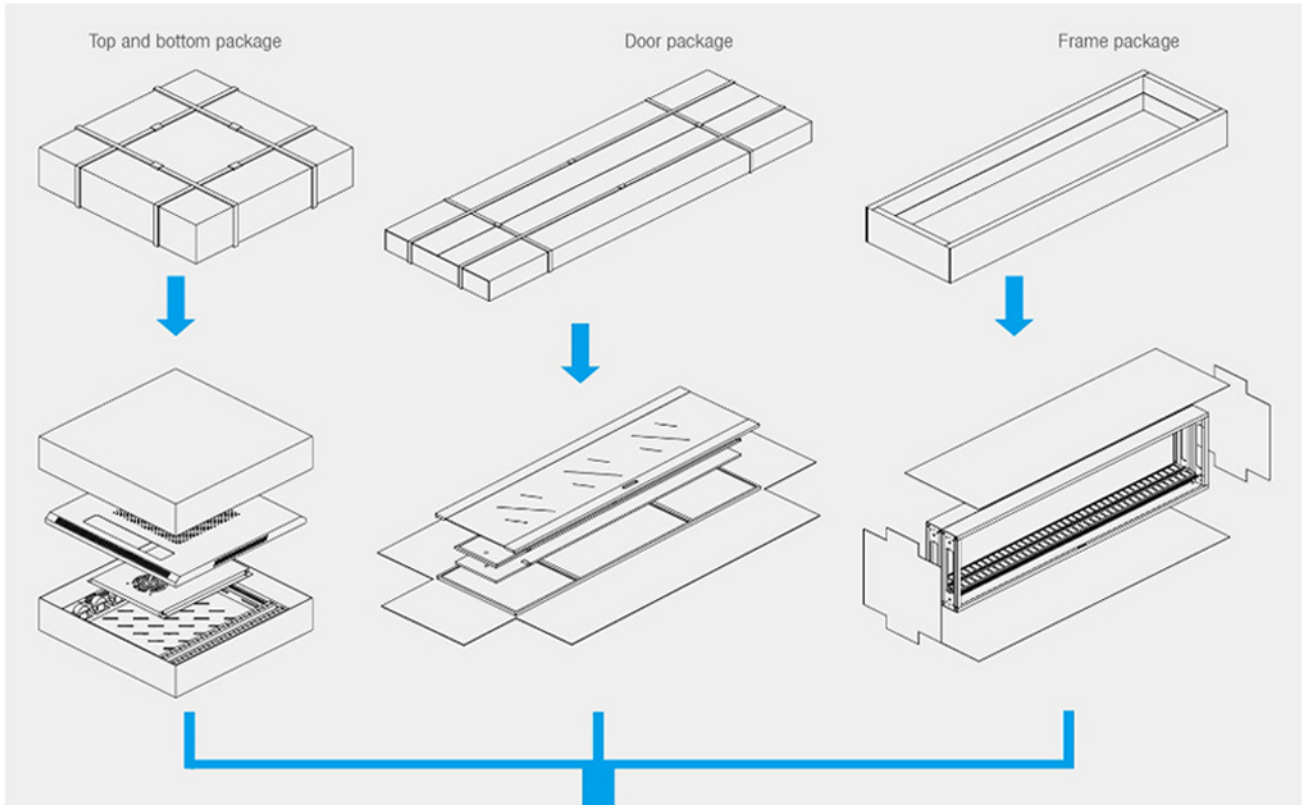

Exploded view



Assembled view

RACK IMAGES



FRONT DOOR



REAR DOOR